



DMS
International

THE BEST CHOICE

for a green future



IT // EN



in the sign of tannery

DMS
RCPaint

Belt

DMS
RC Paint
Belt

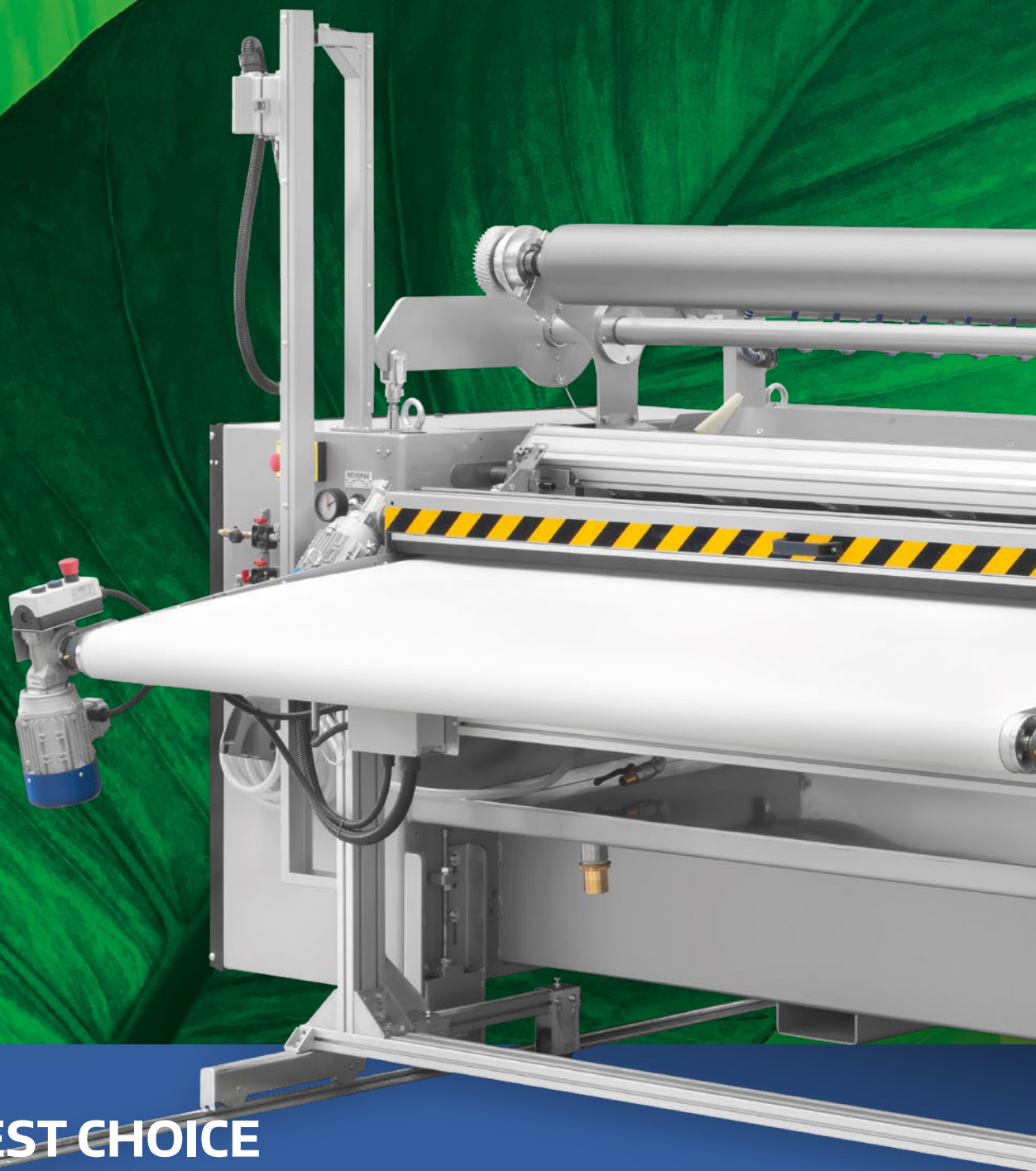

THE BEST CHOICE for a green future

Larghezza utile di lavoro:
1800 - 2200 - 2400 mm
// Usable working width:
1800 - 2200 - 2400 mm

Lama Racla ad inserimento
lineare e pneumatico
// Squeegee Blade linear
and pneumatic insertion

Adatto a tutti
i tipi di pelle
// Suitable for
all leather types

Sistema bloccaggio
introduttore pelle
// Locking system
introducer leather

RC Paint è l'innovativa macchina tamponatrice per la rifinitura a rullo delle pelli.

Sintesi perfetta tra tecnologia, semplicità e sensibilità ecologica.

RC Paint è adatta alla maggior parte dei tipi di pelle, morbide e rigide, ed è l'ideale per applicazione di stucchi, impregnazione, coperture, ingrassi a caldo

e freddo, applicazione di prodotti schiumati su croste, smerigliati o pieno fiore.

RC Paint migliora la qualità stessa delle pelli trattate, grazie all'aggiunta di componenti in acciaio inox che ne assicurano una maggiore pulizia nel processo di lavorazione.

Larghezza utile di lavoro disponibile: **1800 - 2200 - 2400 mm.**

RC Paint is the innovative coating machine for roller finishing of leather.

A perfect synthesis between technology, simplicity and ecological sensitivity.

RC Paint is suitable for most leather types, soft and rigid, and is ideal for application of stucco, impregnation, coating, hot and cold oils,

application of foamed chemicals on splits, buffed or full grain.

RC Paint improves the quality of the treated leathers, thanks to the addition of stainless steel components that ensure greater cleanliness in the production process.

Usable working width available: **1800 - 2200 - 2400 mm.**



Porte scorrevoli per una agevole manutenzione
// Sliding doors for easy maintenance

Pannello comandi analogici con touch screen
// Analog control panel with touch screen

Macchina facilmente mobile su rotaia
// Easily move machine along the rails

« Più cercavamo di realizzare uno strumento completo e innovativo e più la **RC Paint** si trasformava in una macchina semplice, intuitiva, veloce.

The more we tried to realize a complete and innovative tool and the more **RC Paint** became a simple, intuitive, fast machine. »

Carrello con tappeto gommato // Rubber belt

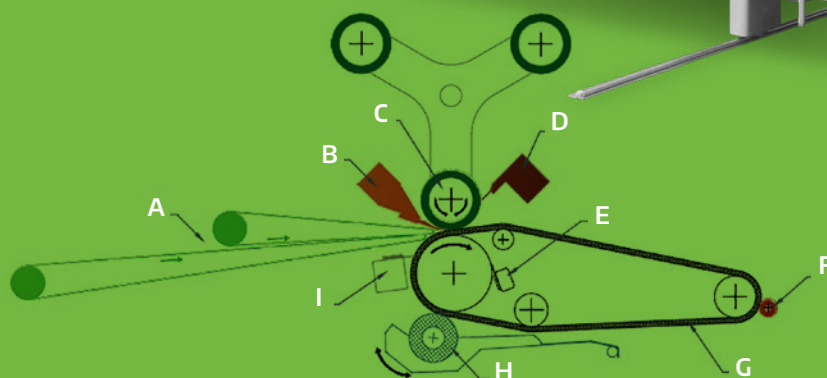
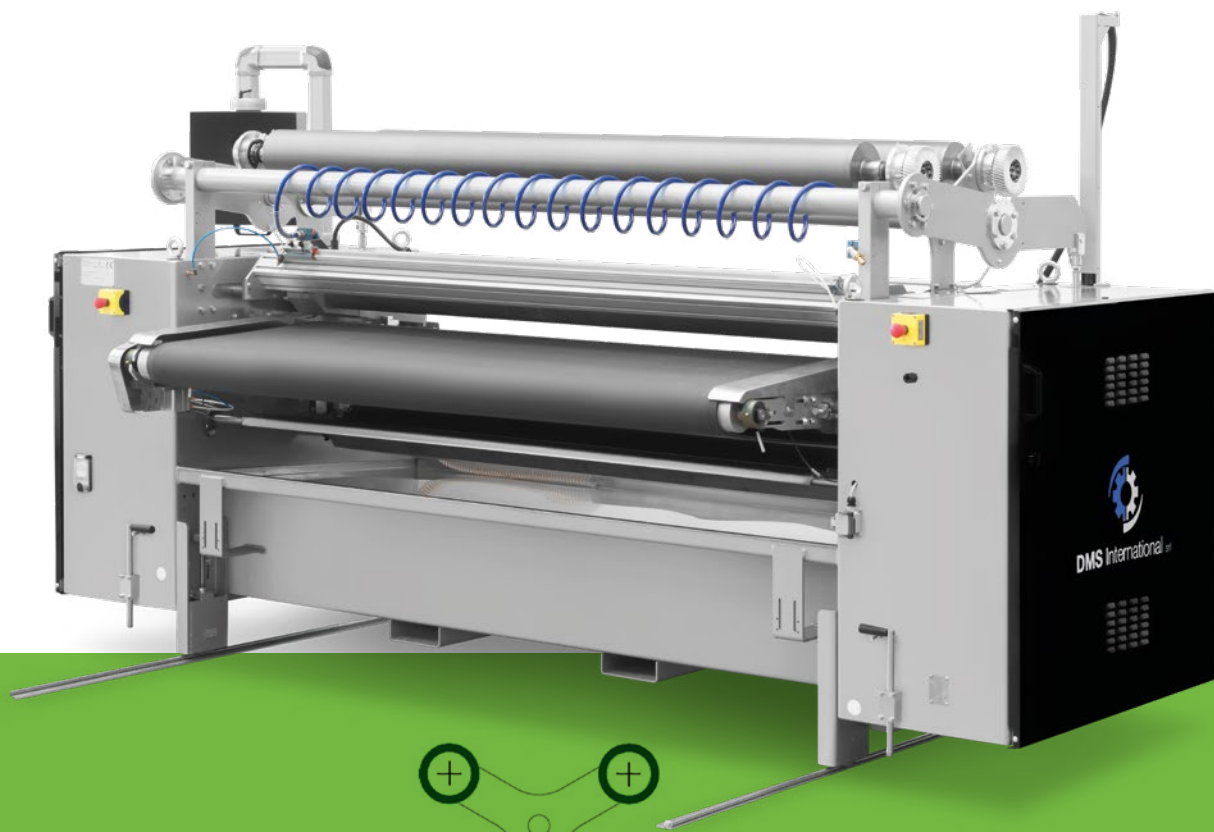

- A Spreader // Spreader
- B Lama Introduzione // Introduction Blade
- C Cilindro Inciso // Cylinder
- D Lama Racla "Reverse" // Doctor Blade "Reverse"
- E Raschiatore // Scraper
- F Rulliera Staccapelli // Detaching Device
- G Tappeto Gommato // Rubber Belt
- H Spazzola di Lavaggio // Washing Brush
- I Lama Tergi // Wiper Blade
- L Rapporto tra il Rullo Traino del Tappeto Gommato e Cilindro Inciso compreso tra $1.37 \div 1.39$ // Ratio Cylinders between $1.37 \div 1.39$



Watch RC Paint
on YouTube:
bit.ly/2JNfKXk

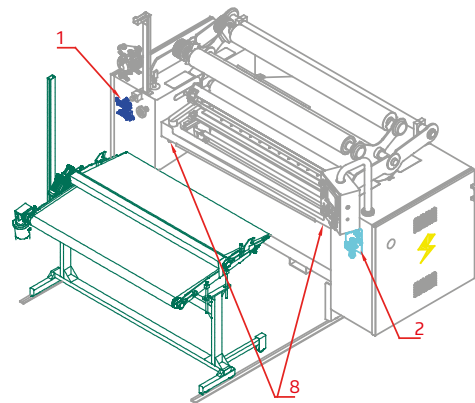
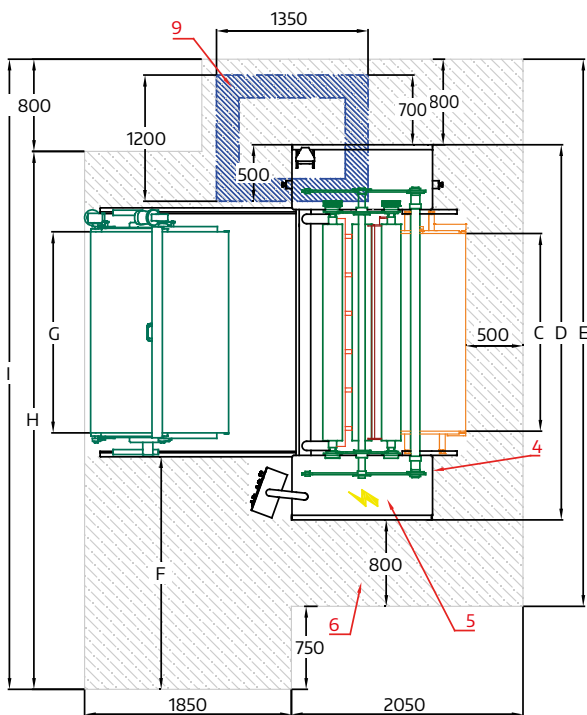
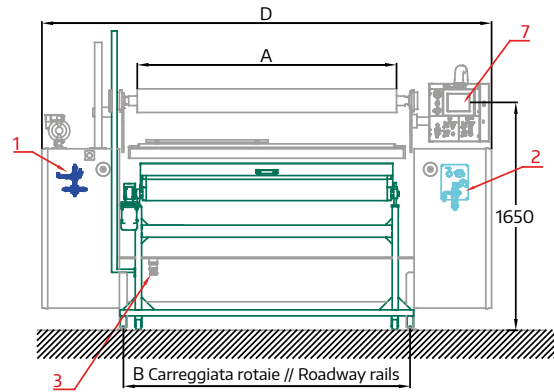
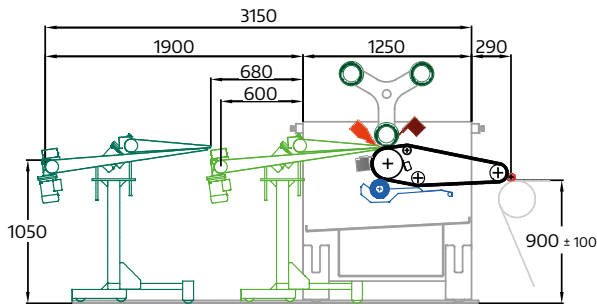

- 1 **Connessione idraulica tubo Ø 14 mm**
// Hydraulic connection, tube Ø 14 mm
- 2 **Attacco aria compressa Ø 1/4" - 7 bar**
// Air connection, Ø 1/4" - 7 bar
- 3 **Scarico Ø 1" 1/2 tubo Ø 50 mm**
// Hydraulic drain Ø 1" 1/2 - tube Ø 50 mm
- 4 **Entrata connessione elettrica**
// Electrical connection entry
- 5 **Quadro elettrico a bordo macchina**
// General electrical panel on-board
- 6 **Area di manutenzione** // Maintenance area
- 7 **Pannello comandi** // Control panel
- 8 **Scarico prodotto recuperato**
// Recovered product drain
- 9 **Canalina a pavimento per scarico acqua**
// Floor drainage

LARGHEZZA DI LAVORO // WORKING WIDTH	A	B	C	D	E	F	G	H	I	PESO MACCHINA // WEIGHT MACHINE	POTENZA INSTALLATA // INSTALLED POWER	CONSUMO D'ARIA // AIR USE
1800	1915	2119	1750	3320	4850	2050	1780	4750	5600	2450 kg	5 kW	1680 l/h
2200	2315	2519	2150	3720	5250	2450	2180	5550	6400	2750 kg		
2400	2515	2719	2350	3920	5450	2650	2380	5950	6800	2900 kg		

Chi siamo // About us

Dietro l'innovativo progetto **RC Paint** c'è **DMS International**, realtà nata nel 2017 come costola di **DMS Italia** per rispondere alla continua richiesta di un macchinario innovativo e performante, conta un team di 14 professionisti motivati e forti di una lunga esperienza nel settore.

// Behind the innovative project **RC Paint** there **DMS International**, company founded in 2017 as an offshoot of **DMS Italy** to meet the continuous demand of an innovative and powerful machine, has a team of 14 professionals motivated and armed with a long experience in the field.

Perchè sceglierci // Why choose us



Esperienza ed affidabilità

// Experience and reliability



Completa conoscenza del mercato e soluzione precisa alle problematiche tecniche più comuni

// Complete knowledge of the market and accurate solution to the technical problems common



Efficiente servizi di post vendita e garanzia di assistenza continuativa

// Efficient after-sales service and guarantee of continuous assistance



DMS International

Via E. De Nicola, 21
36075 Montecchio Maggiore (VI) - Italy

T. +39 0444 451080
info@dmsinternational.it



dmsinternational.it